

A range of electronic components for use in design folios

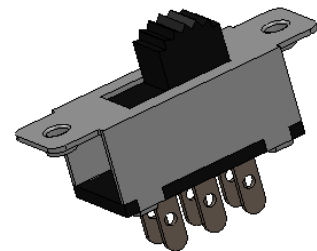

Electronic content.doc

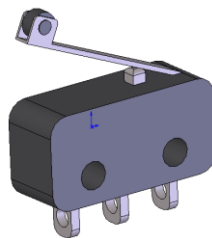
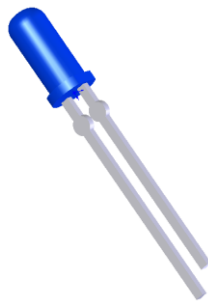
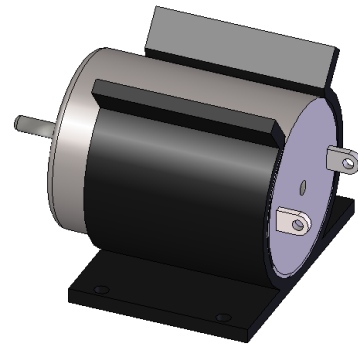
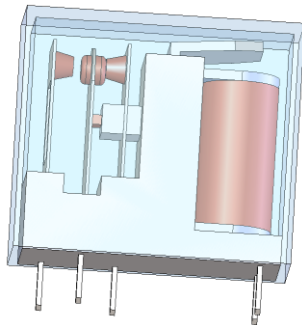
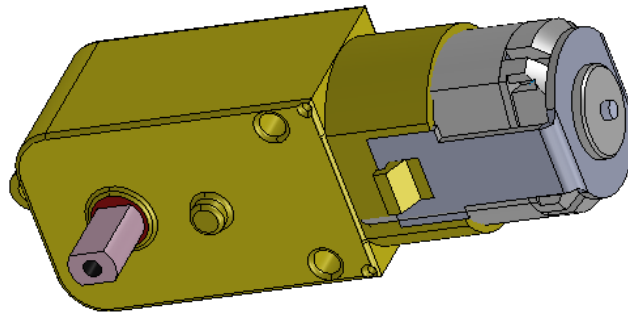
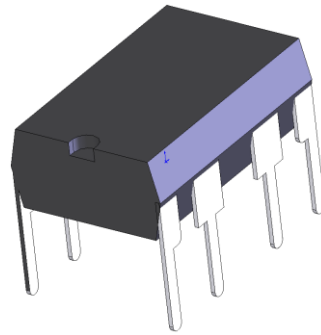
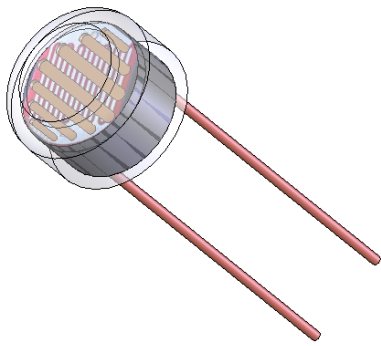

---**555 Timer**
555 Timer.SLDPRT



---**9v battery clip**
battery 9v.SLDPRT
battery and clip 9v.SLDASM
clip 9v.SLDPRT



---**battery clip 1.5 x 2**
battery clip 1.5 x 2.SLDPRT
Battery clip and batteries.SLDASM
battery.SLDPRT



---**Bulb**
bulb and holder.SLDASM
bulb holder.SLDPRT
bulb.SLDPRT
Internal body.SLDPRT
Filament ring.SLDPRT
bulb assembly.SLDASM



---**Capacitor**
capacitor.SLDPRT



---**LDR**
base.SLDPRT
Circuitry.SLDPRT
Clear casing.SLDPRT
ldr.jpg
ldr.pdf
Light dependent resistor.SLDASM



---**LED**
LED blue.SLDPRT
LED Green.SLDPRT
LED Red.SLDPRT
LED Yellow.SLDPRT
LED.SLDPRT

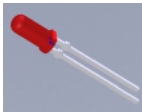



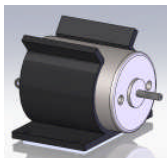



---**Microswitch**
microswitch rollerball.SLDPRT
microswitch.SLDPRT

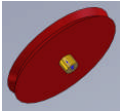

---**Motor 9v**
motor and mount.SLDASM
motor ass.SLDASM
Motor Housing1.SLDPRT
Motor Mount.SLDPRT
Spindle1.SLDPRT

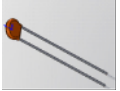
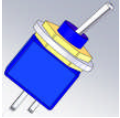

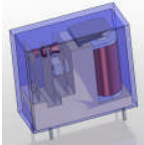
---**Potentiometer**
adjusting pin.SLDPRT
base.SLDPRT
shim.SLDPRT
variable resistor.SLDASM

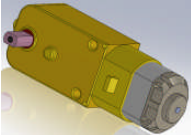
	<p>---PTM Switch PTM switch.SLDPRT</p>
	<p>---Pulleys 25mm pulley.SLDPRT 40mm pulley.SLDPRT 50mm pulley.SLDPRT</p>
	<p>---Reed Switch Casing.SLDPRT Leg.SLDPRT Reed switch.SLDASM</p>
	<p>---Slider switch sliderswitch.SLDPRT</p>
	<p>---Thermistor Thermistor.SLDPRT</p>
	<p>---Toggle switch base.SLDPRT nut.SLDPRT toggle switch.SLDASM toggle.SLDPRT washer.SLDPRT</p>
	<p>---Transistor BC108.SLDPRT TIP121.SLDPRT</p>
	<p>---Diode Diode.SLDPRT</p>
	<p>---Relay base.SLDPRT casing.SLDPRT Electromagnetic Relay single.SLDASM windings.SLDPRT</p>
	<p>---Resistor Resistor.SLDPRT</p>
	<p>---Motor Gearbox Small Motor Gearbox.SLDASM</p>

22 Folder(s) with 60 File(s)